



# Owner's Manual

## TABLE OF CONTENTS

	<b>PAGE</b>
A NOTE ABOUT SAFETY .....	2
GENERAL.....	3
FCC .....	5
WIRELESS REMOTE CONTROLLER.....	6
INDOOR UNIT DISPLAY .....	11
ADDITIONAL FEATURES .....	12
CARE AND MAINTENANCE.....	13
TROUBLESHOOTING.....	15
ERROR CODES .....	17



**Fig. 1 — Sizes 06K - 36K**

### NOTE TO EQUIPMENT OWNER:

Please read this Owner's Information Manual carefully before installing and using this appliance and keep this manual for future reference.

For your convenience, please record the model and serial numbers of your new equipment in the spaces provided. This information, along with the installation data and dealer contact information, will be helpful should your system require maintenance or service.

**UNIT INFORMATION**

Model # \_\_\_\_\_

Serial # \_\_\_\_\_

**INSTALLATION INFORMATION**

Date Installed \_\_\_\_\_

**DEALERSHIP CONTACT INFORMATION**

Company Name: \_\_\_\_\_

Address: \_\_\_\_\_

Phone Number: \_\_\_\_\_

Technician Name: \_\_\_\_\_





## A NOTE ABOUT SAFETY

Any time you see this symbol  in manuals, instructions and on the unit, be aware of the potential for personal injury. There are 3 levels of precaution:

1. **DANGER** identifies the most serious hazards which will result in severe personal injury or death.
2. **WARNING** signifies hazards that could result in personal injury or death.
3. **CAUTION** is used to identify unsafe practices which could result in minor personal injury or product and property damage.

**NOTE** is used to highlight suggestions which will result in enhanced installation, reliability, or operation.

The following symbols may be seen on the unit.

Explanation of symbols displayed on the indoor unit or outdoor unit		
	<b>WARNING</b>	This symbol shows that this appliance used a flammable refrigerant. If the refrigerant is leaked and exposed to an external ignition source, there is a risk of fire.
	<b>CAUTION</b>	This symbol shows that the operation manual should be read carefully.
	<b>CAUTION</b>	This symbol shows that a service personnel should be handling this equipment with reference to the installation manual.
	<b>CAUTION</b>	This symbol shows that information is available such as the operating manual or installation manual.

 **WARNING**

**PERSONAL INJURY, DEATH AND / OR PROPERTY DAMAGE HAZARD**

Failure to follow this warning could result in personal injury, death or property damage.

Improper installation, adjustment, alteration, service, maintenance, or use can cause explosion, fire, electrical shock, or other conditions which may cause personal injury or property damage. Consult a qualified installer, service agency, or your distributor or branch for information or assistance. The qualified installer or service agency must use factory-authorized kits or accessories when modifying this product.

Read and follow all instructions and warnings, including labels shipped with or attached to the unit before operating your new air conditioner.

 **WARNING**

**PERSONAL INJURY AND PROPERTY DAMAGE HAZARD**

For continued performance, reliability, and safety, the only approved accessories and replacement parts are those specified by the equipment manufacturer. The use of non-manufacturer approved parts and accessories could invalidate the equipment limited warranty and result in a fire risk, equipment malfunction, and failure.

Please review the manufacturer's instructions and replacement parts catalogs available from your equipment supplier.

 **WARNING**

This appliance is not intended for use by persons (including children) with reduced physical, sensory or mental capabilities, or lack of experience and knowledge, unless they have been given supervision or instruction concerning use of the appliance by a person responsible for their safety. Children should be supervised to ensure that they do not play with the appliance.

 **WARNING**

**FOR FLAMMABLE REFRIGERANTS**

Do not use means to accelerate the defrosting process or to clean, other than those recommended by the manufacturer.

The appliance shall be stored in a room without continuously operating ignition sources (for example: open flames, an operating gas appliance or an operating electric heater).

Do not pierce or burn.

Be aware that refrigerants may not contain an odor.

**R-454B**

Refrigerant  
Safety Group  
A2L

**R-454B**

**WARNING – Risk of Fire due to Flammable Refrigerant Used. Follow Handling Instructions Carefully in Compliance with National Regulations**

**NOTE: Risk of Fire. Flammable refrigerant used. To be repaired only by trained service personnel. Do not puncture refrigerant tubing.**

## GENERAL

The indoor unit provides quiet, maximum comfort. In addition to cooling and/or heating, the indoor unit matched with an outdoor condensing unit filters and dehumidifies the air in the room to provide maximum comfort.

**IMPORTANT: The indoor unit should be installed by authorized personnel only; using approved tubing and accessories. If technical assistance, service or repair is needed, contact the installer. The indoor unit can be set up and operated from the remote control (provided). If the remote is misplaced, the system can be operated from the "Auto" setting on the unit.**

### Operating Modes:

The indoor unit has five operating modes:

- **FAN Only**
- **AUTO**
- **HEATING (heat pumps only)**
- **COOLING**
- **DEHUMIDIFICATION**

### FAN Only

In the **FAN Only** mode, the system filters and circulates the room air without changing room air temperature.

### AUTO

In the **AUTO** mode, the system automatically cools or heats the room according to the user-selected set point.

**NOTE: AUTO mode is recommended for use on single zone applications ONLY. Using AUTO CHANGEOVER on multi-zone applications could set an indoor unit to STANDBY mode, indicated with two dashes (--) on the display, which turns off the indoor unit until all the indoor units are in the same mode (COOLING or HEATING). HEATING is the system's priority mode. Simultaneous HEATING and COOLING is not allowed.**

### HEATING (Heat Pump models only)

In the **HEATING** mode, the system heats and filters the room air.

### COOLING

In the **COOLING** mode, the system cools, dries and filters the room air.

### DEHUMIDIFICATION (DRY)

In the **DEHUMIDIFICATION** mode, the system dries, filters and slightly cools the room air temperature. This mode prioritizes air dehumidification but it does not take the place of a dehumidifier.

## Wireless Remote Control

The remote control transmits commands to set up and operate the system. The control has a window display panel that displays the current system status. The control can be secured to a surface when used with the mounting bracket provided.

## Wired Remote Control (Optional)

Refer to the Wired Controller manual.

## 24V Interface (Optional)

Allows the control of the Ductless System with a third party thermostat.

### 1. Installation (where refrigerant pipes are allowed)

Any person who is involved with working on or breaking into a refrigerant circuit should hold a current valid certificate from an industry-accredited assessment authority, which authorizes their competence to handle refrigerants safely in accordance with an industry recognized assessment specification.

Maintenance and repair requiring the assistance of other skilled personnel shall be carried out under the supervision of the person competent in the use of flammable refrigerants.

The installation of pipe-work shall be kept to a minimum.

Pipe-work shall be protected from physical damage.

Where refrigerant pipes shall be compliance with national gas regulations. That mechanical connections shall be accessible for maintenance purposes.

Be more careful that foreign matter (oil, water, etc.) does not enter the piping. When storing the piping, securely seal the opening by pinching, taping, etc. All working procedure that affects safety means shall only be carried by competent persons.

Appliance shall be stored in a well ventilated area where the room size corresponds to the room area as specific for operation.

Joints shall be tested with detection equipment with a capability of 1/8 oz (5g)/year of refrigerant or better, with the equipment in standstill and under operation or under a pressure of at least these standstill or operation conditions after installation. In cases that require mechanical ventilation, ventilation openings shall be kept clear of obstruction.

**LEAK DETECTION SYSTEM** installed. Unit must be powered except for service. For the unit with refrigerant sensor, when the refrigerant sensor detects refrigerant leakage, the indoor unit displays a error code and emit a buzzing sound, the compressor of outdoor unit immediately stops, and the indoor fan starts running. The service life of the refrigerant sensor is 15 years. When the refrigerant sensor malfunctions, the indoor unit displays the error code **FHCC**. Refer to the error code table in the unit's service manual for details. The refrigerant sensor can not be repaired and can only be replaced by the manufacturer. It shall only be replaced with the sensor specified by the manufacturer.

2. Because a **FLAMMABLE REFRIGERANT** is used, the requirements for installation space of appliance and/or ventilation requirements are determined according to:
  - the refrigerant charge used in the appliance,
  - the installation location,
  - the type of ventilation of the location or of the appliance.
 piping material, pipe routing, and installation shall include protection from physical damage in operation and service, and be in compliance with national and local codes and standards, such as ASHRAE 15, IAPMO Uniform Mechanical Code, ICC International Mechanical Code, or CSA B52. All field joints shall be accessible for inspection prior to being covered or enclosed.
  - that protection devices, piping, and fittings shall be protected as far as possible against adverse environmental effects, for example, the danger of water collecting and freezing in relief pipes or the accumulation of dirt and debris;
  - that piping in refrigeration systems is designed and installed to minimize the likelihood of hydraulic shock damaging the system;
  - that steel pipes and components shall be protected against corrosion with a rustproof coating before applying any insulation;
  - that precautions shall be taken to avoid excessive vibration or pulsation;
  - the minimum floor area of the room shall be mentioned in the form of a table or a single figure without reference to a formula;
  - after completion of field piping for split systems, the field pipe-work shall be pressure tested with an inert gas and then vacuum tested prior to refrigerant charging, according to the following requirements:

- a. The required nitrogen test pressure is 500 PSI.
  - b. The test pressure after removal of pressure source shall be maintained for at least 1 hour with no decrease of pressure indicated by the test gauge, with test gauge resolution not exceeding 5% of the test pressure.
  - c. During the evacuation test, after achieving a vacuum level specified in the manual or less, the refrigeration system shall be isolated from the vacuum pump and the pressure shall not rise above 1500 microns within 10 min. The vacuum pressure level shall be specified in the manual, and shall be the lesser of 500 microns or the value required for compliance with national and local codes and standards, which may vary between residential, commercial, and industrial buildings.
- Field-made refrigerant joints indoors shall be tightness tested according to the following requirements: The test method shall have a sensitivity of 1/8 oz (5 g) per year of refrigerant or better under a pressure of at least 125% of the maximum allowable pressure. No leak shall be detected.

### 3. Qualification of Workers

Any maintenance, service and repair operations must be performed by skilled and authorized personnel. Every working procedure that affects safety means shall only be carried out by competent persons that joined the training and achieved competence should be documented by a certificate. The training of these procedures is carried out by national training organizations or manufacturers that are accredited to teach the relevant national competency standards that may be set in legislation. Examples for such working procedures are:

- breaking into the refrigerating circuit;
- opening of sealed components;
- opening of ventilated enclosures.

### 4. Ventilated Area

Ensure that the area is in the open or that it is adequately ventilated before breaking into the system or conducting any hot work. A degree of ventilation shall continue during the period that the work is carried out. The ventilation should safely disperse any released refrigerant and preferably expel it externally into the atmosphere.

### 5. Cabling

Check that cabling is not subjected to wear, corrosion, excessive pressure, vibration, sharp edges or any other adverse environmental effects. The check shall also take into account the effects of aging or continual vibration from sources such as compressors or fans.

### 6. Detection of Flammable Refrigerants

Under no circumstances shall potential sources of ignition be used in the searching for or detection of refrigerant leaks. A halide torch (or any other detector using a naked flame) shall not be used. The following leak detection methods are deemed acceptable for refrigerant systems. Electronic leak detectors that have a sensitivity of 1/8 Oz (5g)/year may be used to detect leaks of flammable refrigerants. (Detection equipment shall be calibrated in a refrigerant free area.) Ensure that the detector is not a potential source of ignition and is suitable for the refrigerant used. Leak detection equipment shall be set at a percentage of the LFL of the refrigerant and shall be calibrated to the refrigerant employed, and the appropriate percentage of gas (25% maximum) is confirmed. Leak detection fluids are also suitable for use in external leak detection.

### NOTE: Examples of leak detection fluids are

- bubble method,
- fluorescent method agents.

**If a leak is suspected, all open flames shall be removed/ extinguished. If a leakage of refrigerant is found which requires brazing, all of the refrigerant shall be recovered from the system, or isolated (by means of shut off valves) in a part of the system remote from the leak. See the following instructions of removal of refrigerant.**

### 7. Evacuation

When breaking into the refrigerant circuit to make repairs - or for any other purpose conventional procedures shall be used. However, for flammable refrigerants it is important that best practice be followed, since flammability is a consideration. The following procedure shall be adhered to:

- safely recover refrigerant following local and national regulations; evacuate;
- purge the circuit with NITROGEN;
- evacuate (requirement);
- continuously flush or purge with NITROGEN when using flame to open circuit; and
- open the circuit

The refrigerant charge shall be recovered into the correct recovery cylinders. Charging must be performed by the liquid charging method. For appliances containing flammable refrigerants, the system shall be purged with oxygen-free nitrogen to render the appliance safe for flammable refrigerants. This process might need to be repeated several times. Compressed air or oxygen shall not be used for purging refrigerant systems.

For appliances containing flammable refrigerants, refrigerants purging shall be achieved by breaking the vacuum in the system with oxygen-free nitrogen and continuing to fill until the working pressure is achieved, then venting to atmosphere, and finally pulling down to a vacuum (requirement). This process shall be repeated until no refrigerant is within the system (requirement). When the final oxygen-free nitrogen charge is used, the system shall be vented down to atmospheric pressure to enable work to take place. The outlet for the vacuum pump shall not be close to any potential ignition sources, and ventilation shall be available.

**Recovery:** When removing refrigerant from a system, either for servicing or decommissioning, it is recommended good practice that all refrigerants are removed safely.

When transferring refrigerant into cylinders, ensure that only appropriate refrigerant recovery cylinders are employed. Ensure that the correct number of cylinders for holding the total system charge is available. All cylinders to be used are designated.

### 8. Charging Procedures

In addition to conventional charging procedures, the following requirements shall be followed:

Works shall be undertaken with appropriate tools only (in case of uncertainty, consult the manufacturer of the tools for use with flammable refrigerants)

Ensure that contamination of different refrigerants does not occur when using charging equipment. Hoses or lines shall be as short as possible to minimize the amount of refrigerant contained in them. Charging must be performed by the liquid charging method.

Ensure that the refrigeration system is grounded prior to charging the system with refrigerant.

Label the system when charging is complete (if not already).

Extreme care shall be taken not to overfill the refrigeration system.

Prior to recharging the system it shall be pressure tested with oxygen free nitrogen (OFN). The system shall be leak tested on completion of charging but prior to commissioning. A follow up leak test shall be carried out prior to leaving the site.

## FCC

This device complies with part 15 of the FCC Rules. Operation is subject to the following two conditions: (1) This device may not cause harmful interference, and (2) this device must accept any interference received, including interference that may cause undesired operation.

### For Class B Digital Device

**NOTE: This equipment has been tested and found to comply with the limits for a Class B digital device, pursuant to part 15 of the FCC Rules. These limits are designed to provide reasonable protection against harmful interference in a residential installation. This equipment generates, uses and can radiate radio frequency energy and, if not installed and used in accordance with the instructions may cause harmful interference to radio communications. However, there is no guarantee that interference will not occur in a particular installation. If this equipment does cause harmful interference to radio or television reception, which can be determined by turning the equipment off and on, the user is encouraged to try to correct the interference by one or more of the following measures:**

- Reorient or relocate the receiving antenna
- Increase the distance between the equipment and the receiver
- Connect the equipment into an outlet on a circuit different from that to which the receiver is connected.
- Consult the dealer or an experienced radio/TV technician for assistance.

**MODIFICATION:** Any changes or modifications not expressly approved by the grantee of this device could void the user's authority to operate this device.

<b>Supplier's Declaration of Conformity Per FCC Part 2 Section 2.1077</b>	
<b>Unique Identifier:</b> (e.g., Trade Name, Model Number)	
<b>Responsible Party - U.S. Contact Information</b>	
Company name: *****	
Street Address: *****	
City, State : *****	
Postal Code : *****	
United States : *****	
Telephone number or internet contact information: ****	
<b>FCC Compliance Statement</b>	
This device complies with Part 15 of the FCC Rules. Operation is subject to the following two conditions: (1) This device may not cause harmful interference, and (2) this device must accept any interference received, including interference that may cause undesired operation.	

# WIRELESS REMOTE CONTROLLER

Before you begin using your new air conditioner, familiarize yourself with the remote control.

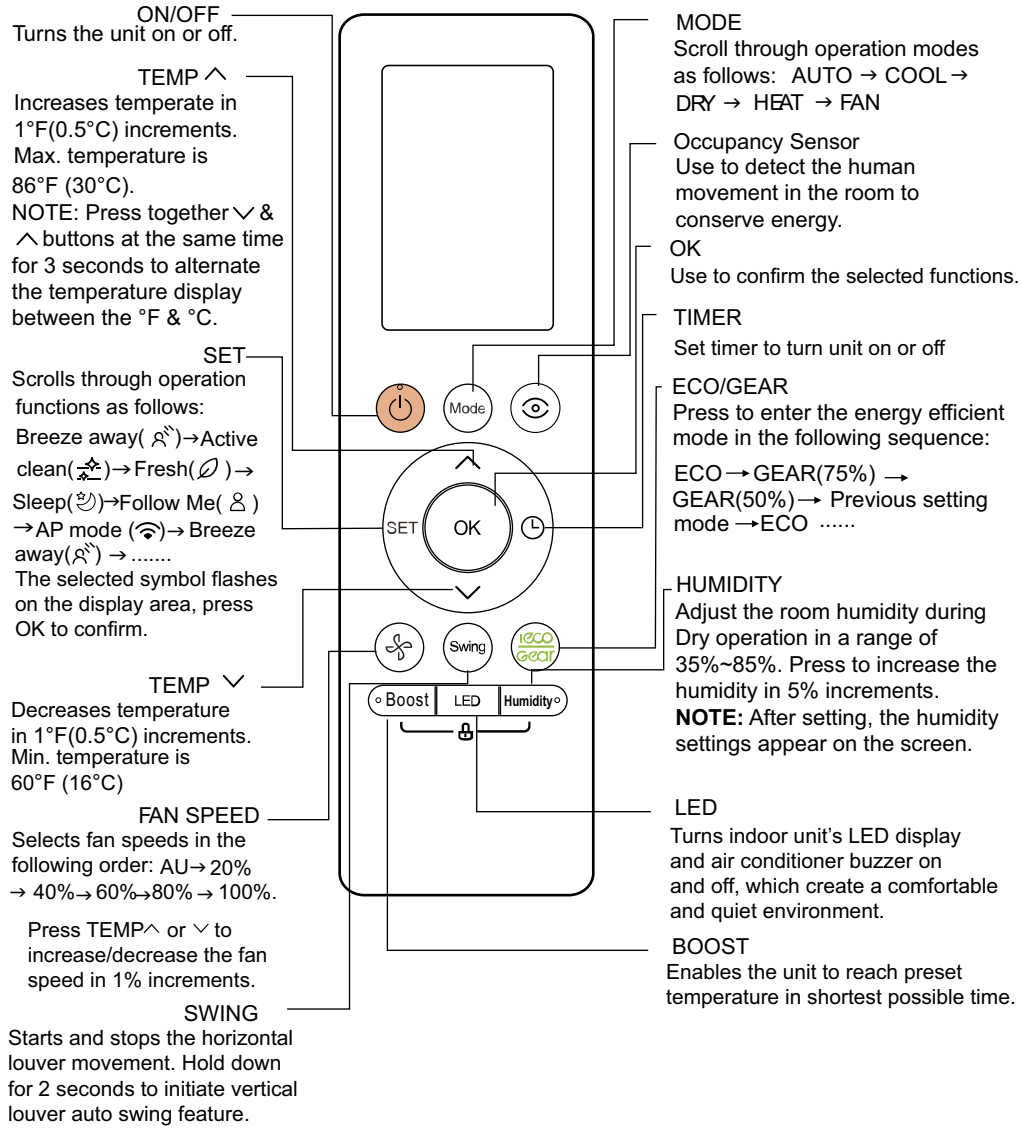
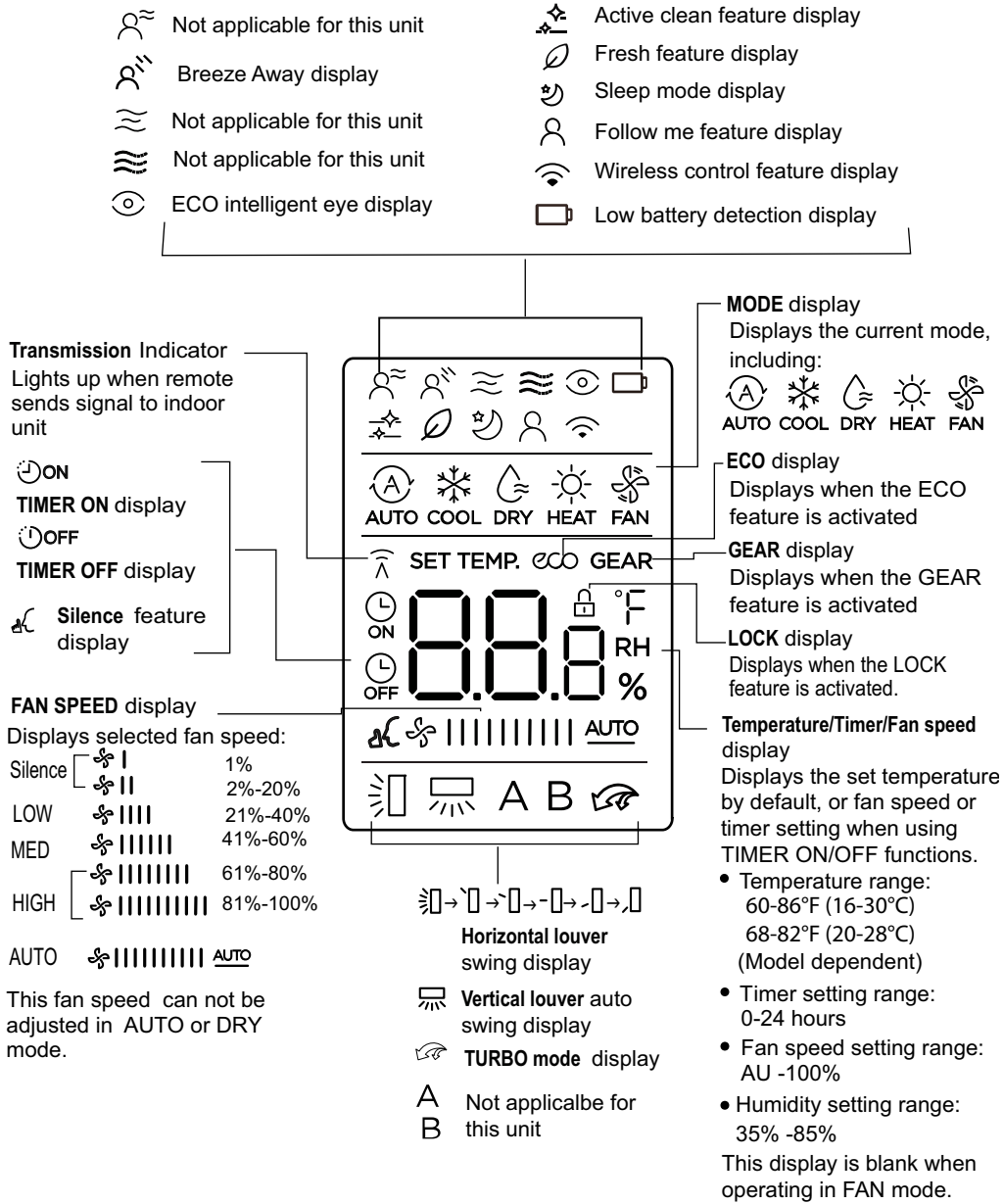

Fig. 2 — Remote Control Functions

## WIRELESS REMOTE CONTROL LCD SCREEN INDICATORS

Information appears when the remote controller is on.



**Fig. 3 — Wireless Remote Controller Indicators**

**NOTE:** When matching with Multi-Zone condensers, Intelligent Sensor, Humidity Control, ECO, Active Clean, Gear; Breeze Away and Silent modes will be not available.

## REMOTE CONTROLLER



### CAUTION

#### EQUIPMENT DAMAGE HAZARD

Failure to follow this caution may result in equipment damage. Handle the control with care and avoid getting the control wet.

**IMPORTANT:** The remote control can operate the unit from a distance of up to 26 ft. (8 m) as long as there are no obstructions. When the timer function is used, the remote control should be kept in the vicinity of the fan coil (within 26 ft. / 8 m).

The remote control can perform the following basic functions:

- Turn the system ON and OFF
- Select the operating mode
- Adjust room air temperature set point and fan speed
- Adjust right-left airflow direction

Refer to the “WIRELESS REMOTE CONTROLLER” on page 6 for a detailed description of all the capabilities of the remote control.

### Battery Installation

Two AAA 1.5v alkaline batteries (included) are required for remote control operation.

#### To install or replace batteries:

1. Slide the back cover off the control to open the battery compartment.
2. Insert the batteries. Follow the polarity markings inside the battery compartment.
3. Replace the battery compartment cover.

#### NOTES:

1. When replacing batteries, do not use old batteries or a different type battery. This may cause the remote control to malfunction.
2. If the remote is not going to be used for several weeks, remove the batteries. Otherwise, battery leakage may damage the remote control.
3. The average battery life under normal use is about 6 months.
4. Replace the batteries when there is no audible beep from the indoor unit or if the Transmission Indicator fails to light.

When batteries are removed, the remote control erases all presets (e.g., **Follow Me**). The presets must be restored after the insertion of new batteries.

## BASIC REMOTE CONTROL OPERATION

Before operation, ensure the unit is plugged in and power is available.

### COOL Mode

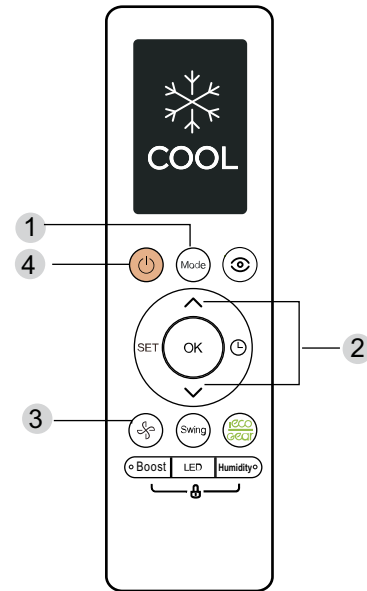

**Fig. 4 — COOL Mode**

1. Press **MODE** to select the **COOL** mode.
2. Set your desired temperature using the **UP** or **DOWN** arrows.
3. Press **FAN** to select the fan speed in a range of AU\*100%.
4. Press **ON/OFF** to start the unit.

### Setting Temperature

The operating temperature range for units is 60-86°F (16-30°C)/(68-82 °F (20-28°C) (depends on model). You can increase or decrease the set temperature in 1°F(0.5°C) increments.

**HEAT Mode**

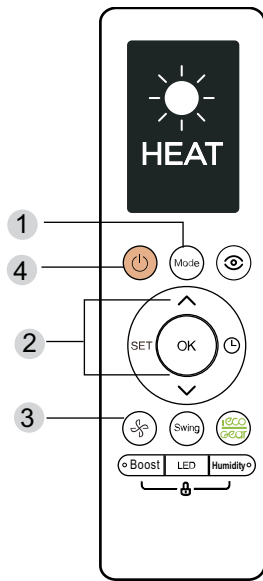

**Fig. 5 — HEAT Mode**

1. Press **MODE** to select the **HEAT** mode.
2. Set your desired temperature using the **UP** or **DOWN** arrows.
3. Press **FAN** to select the fan speed in the range of AU-100%.

**NOTE:** As the outdoor temperature drops, the performance of your unit's **HEAT** function may be affected. In such instances, we recommend using this air conditioner in conjunction with other heating appliances.

**AUTO Mode**

In **AUTO** mode, the unit automatically selects the **COOL**, **FAN**, or **HEAT** operation based on the set temperature.

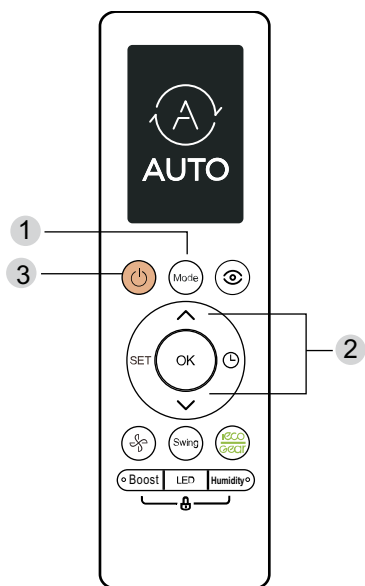
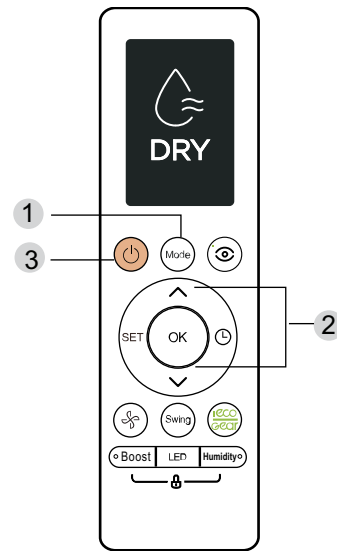

**Fig. 6 — AUTO Mode**

1. Press **MODE** to select **AUTO**.
2. Set your desired temperature using the **UP** or **DOWN** arrows.
3. Press **ON/OFF** to start the unit.

**NOTE:** **FAN** Speed can not be set in the **AUTO** mode.

**DRY Mode**



**Fig. 7 — DRY Mode**

1. Press **MODE** to select the **DRY** mode.
2. Set your desired temperature using the **UP** or **DOWN** arrows.
3. Press **ON/OFF** to start the unit.

**FAN Mode**

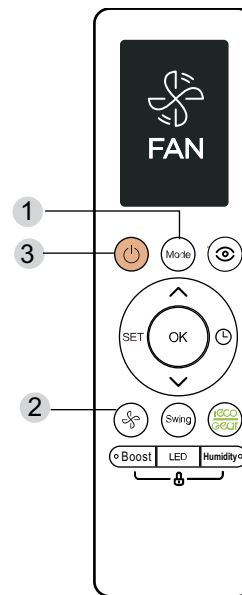

**Fig. 8 — FAN Mode**

1. Press **MODE** to select the **FAN** mode.
2. Press **FAN** to select the fan speed in the range of AU-100%.
3. Press **ON/OFF** to start the unit.

## Remote Control Operation - Quick Start

**NOTE:** When transmitting a command from the remote control to the unit, be sure to point the control toward the right side of the unit. The unit confirms receipt of a command by sounding an audible beep.

1. Turn the unit on by pushing **ON/OFF**.  
**NOTE:** If there is a preference for °C rather than °F (default), press and hold the + and - temperature set point buttons together for approximately 3 seconds.
2. Select the desired mode by pushing **MODE**.



**Fig. 9 — Modes**

3. Select the temperature set point by pointing the control toward the unit and pressing the increase/decrease temperature set point buttons until the desired temperature appears on screen.
4. Press **FAN** to select the desired fan speed.

**NOTE:** If the unit is operating in **DRY** or **AUTO** mode, the fan speed will be automatically set and cannot be adjusted.

Set the airflow direction. When the unit is turned on, the **Up-Down** airflow louvers default to the cooling or heating position. The user can adjust the horizontal Up-Down airflow louver position by pushing **DIRECT** or have continuous louver movement by pressing **SWING**.

**When the outside temperature is below 32°F (0°C), we strongly recommend maintaining power on the unit to ensure smooth ongoing performance.**

**To optimize unit performance, perform the following:**

- Keep doors and windows closed
- Limit energy usage by using **TIMER ON** and **TIMER OFF** functions.
- Do not block air inlets or outlets.

**Regularly inspect and clean air filters.**

## INDOOR UNIT DISPLAY

**NOTE:** Different models have different front panel and display window. Not all the indicators described below are available for the air conditioner you purchased. Please check the indoor display window of the unit you purchased. Illustrations in this manual are for explanatory purposes. The actual shape of your indoor unit may differ.

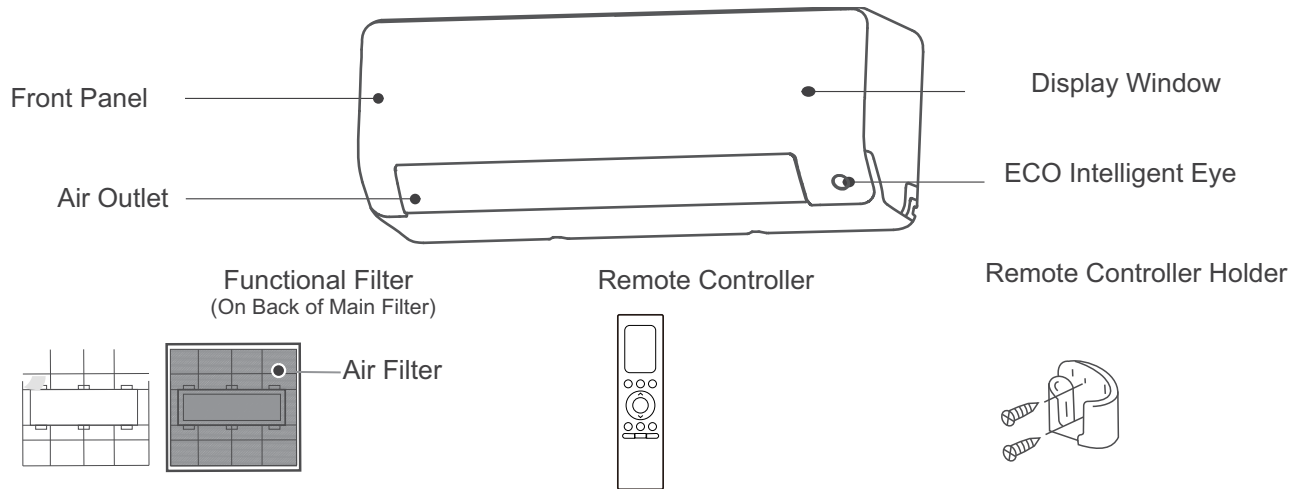









Fig. 10 — High Wall

Display Windows	Display Code Meanings
	• Displays temperature, operation feature and Error codes.
	• When ECO function is activated.
	• When Wireless Control feature is activated(For App control units).
 ( for 3s when)	• TIMER ON is set (if the unit is OFF, the ON indicator remains on when TIMER ON is set ). • SWING, TURBO, ECO, BREEZE AWAY, SILENCE or ECO INTELLIGENT EYE feature is turned on.
 (for 3s when)	• TIMER OFF is set. • SWING, TURBO, ECO, BREEZE AWAY, SILENCE or ECO INTELLIGENT EYE feature is turned off.
	• When Active Clean feature is turned on.
	• When defrosting.
	• When 46°F( 8°C) heating feature is turned on.

## ADDITIONAL FEATURES

**NOTE: Every time the air conditioner is powered on, the unit emits a buzzing sound to indicate that the product has been powered on normally. If there is no sound, it is possible that the unit has malfunctioned. Power on again or check the circuit. The actual functions are subject to the product you purchased, please check the indoor display and remote control of your unit. Review the Remote Controller Manual for more features.**

### Active Clean Function

The Active Clean Technology washes away dust when it adheres to the heat exchanger by automatically freezing and then rapidly thawing the frost. The Active Clean operation is used to produce more condensed water to improve the cleaning effect, and the cold air blows out. After cleaning, the internal wind wheel then keeps operating with hot air to blow-dry the evaporator, thus keeping the inside clean. When this function is turned on, the indoor unit display window appears “CL”, after 20 to 45 minutes, the unit turns off automatically and cancel the Active Clean function.

### ECO Intelligent eye (Applicable to units with Intelligent eye function only)

The system is controlled intelligently under **Intelligent Eye** mode. It can detect the people's activities in the room. In cooling/heating mode, when you are away for 30 minutes, the unit automatically lowers the frequency to save energy. And the unit automatically starts and resumes operation if sensing human activity again.

### AUTO LEAK DETECTION

LEAK DETECTION SYSTEM installed. Unit must be powered except for service. For the unit with refrigerant sensor, when the refrigerant sensor detects refrigerant leakage, the indoor unit displays an error code and emits a buzzing sound, the compressor of outdoor unit immediately stops, and the indoor fan starts running. The service life of the refrigerant sensor is 15 years. When the refrigerant sensor malfunctions, the indoor unit displays the error code **FHCC**. Refer to the error code table in the unit's service manual for details. The refrigerant sensor can not be repaired and can only be replaced by the manufacture. It shall only be replaced with the sensor specified by the manufacture.

**NOTE: The buzzer will continue to “beep” for 5 minutes before stopping. You can also press any button on the remote controller to stop the buzzer.**

### Auto-Restart

If the unit loses power, the unit automatically restarts with the prior settings once power has been restored.

### Louver Angle Memory

When turning on your unit, the louver resumes its former angle.

### Breeze Away

This feature avoids direct air flow blowing on the body.

### Sleep

Use **SLEEP** to decrease energy use while you sleep. Press **SLEEP** on the remote control when in the **COOL** mode, the unit increases the temperature by 2°F (1°C) after 1 hour, and increases an additional 2°F (1°C) after another hour. When in **HEAT** mode, the unit decrease the temperature by 2°F (1°C) after 1 hour, and decreases an additional 2°F (1°C) after another hour. **SLEEP** stops after 8 hours and the system continues to run with final situation.

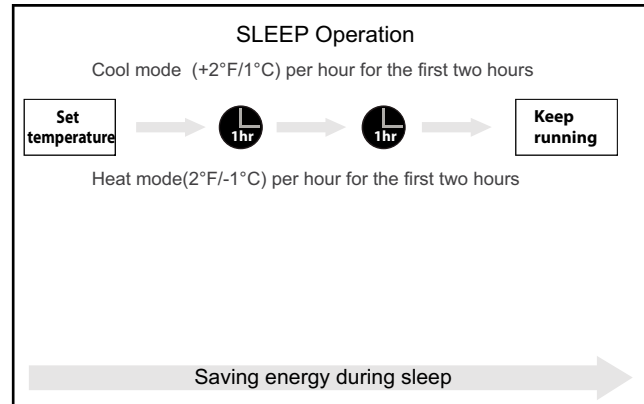

**Fig. 11 — SLEEP Operation**

### Wireless Control (For App control units)

Wireless control allows you to control the air conditioner with a smart phone and a wireless connection. For the USB device access, replacement, maintenance operations must be carried out by professional staff.

### Outdoor Unit Reverse Fan Operation function

This feature helps keep the outdoor coil cleaner and may extend the duration between regular maintenance intervals depending on local conditions. When the unit is turned off, a 10 second delay occurs then the outdoor fan runs in reverse rotation for 70 seconds to blow off loose accumulated dust and debris.

### SETTING AIR FLOW

**NOTE: Setting vertical angle of air flow (remote control). While the unit is on, use SWING to set the direction (vertical/horizontal angle) of airflow. Refer to the Remote Control Manual for details.**

**NOTE: Do not set louver at too vertical an angle for long periods of time. When using COOL or DRY mode, water could condense on the louver blade and drop on your floor or furnishings.**

**NOTE: Setting the louver at too small an angle when using COOL or HEAT mode, can reduce the AC performance due to restricted air flow.**

**NOTE: According to the relative standards requirement, set the vertical air flow louver to its maximum angle under heating capacity test.**

**NOTE: Do not adjust the louver by hand. You can turn off the unit and unplug it for a few seconds to restart the unit. The unit resets the louver.**

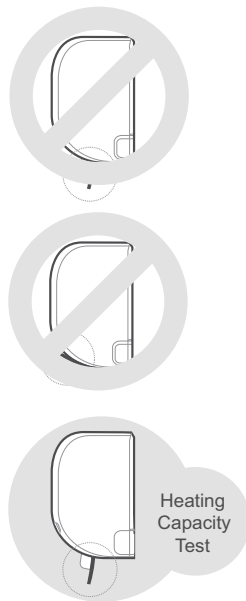

Fig. 12 — Louver Positions

## CARE AND MAINTENANCE

### CAUTION

The cooling efficiency of your unit and your health would be damaged for the clogged AC. Make sure to clean the filter every two weeks.

Always turn off your AC system and disconnect its power supply before cleaning or maintaining.

**Do not** touch the air freshening (Plasma) filter for at least 10 minutes after turning off the unit.

Only use a soft, dry cloth to wipe the unit clean. You can use a cloth soaked in warm water to wipe it clean if the unit is especially dirty.

**Do not** use chemicals or chemically treated cloths to clean the unit

**Do not** use benzene, paint thinner, polishing powder or other solvents to clean the unit. They can cause the plastic surface to crack or deform.

**Do not** use water hotter than 104°F(40°C) to clean the front panel. This can cause the panel to deform or become discolored.

### CAUTION

Do not place your fingers in or near the blower and suction side of the unit. The high-speed fan inside the unit may cause injury.

## Manual Operation (Without Remote)

### CAUTION

The manual button is intended for testing purposes and emergency operation **only**. **Do not** use this function unless the remote control is lost and it is absolutely necessary. To restore regular operation, use the remote control to activate the unit. Unit must be turned off before manual operation.

### To Manually Operate the Unit

1. Open the front panel of the indoor unit.
2. Locate **MANUAL CONTROL** on the right-hand side of the unit.
3. Press **MANUAL CONTROL** one time to activate **FORCED AUTO** mode.
4. Press **MANUAL CONTROL** again to activate **FORCED COOLING** mode.
5. Press **MANUAL CONTROL** a third time to turn the unit off.
6. Close the front panel.

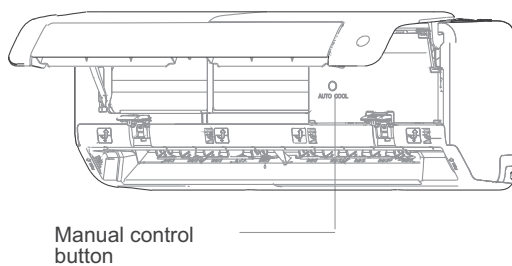

Fig. 13 — Manual Control

## Cleaning Your Indoor Unit, Air Filter

1. The air filter is on the top of the air conditioner. Hold both side of the top filter in the place marked "PULL", then pull it upwards.

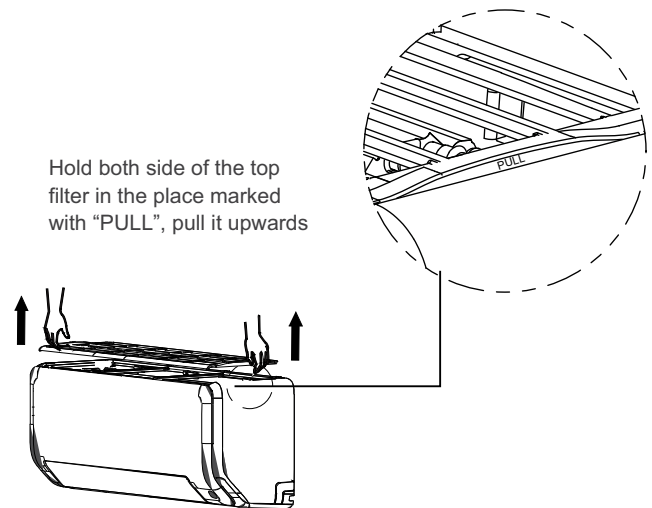

Fig. 14 — Pull

2. If your filter has a small air freshening filter, unclip it from the larger filter. Clean this air freshening filter with a hand-held vacuum.

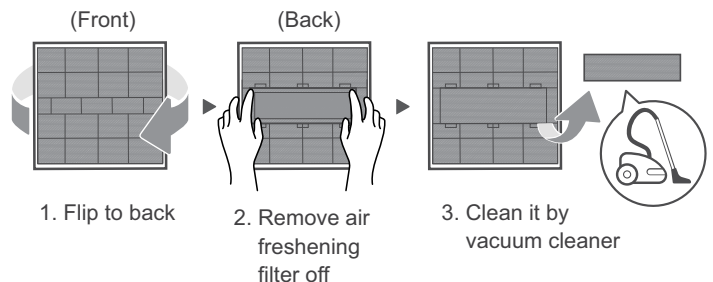
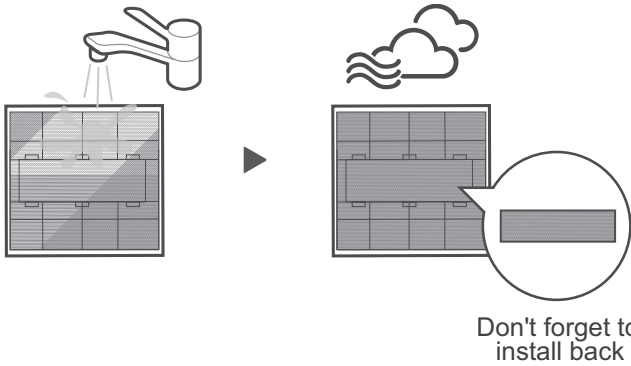

Fig. 15 — Clean Filter

- Clean the large air filter with warm, soapy water. Be sure to use a mild detergent. Rinse the filter with fresh water, then shake off any excess water. Dry it in a cool, dry place, and refrain from exposing it to direct sunlight.



**Fig. 16 — Clean Air Filter And Replace**

- When dry, re-clip the air freshening filter to the larger filter, then install the air filter back on the top of the indoor unit.



**Fig. 17 — Re-clip the Filter**

CAUTION

Before changing the filter or cleaning, turn off the unit and disconnect its power supply.

When removing the filter, refrain from touching the metal parts in the unit. The sharp metal edges can injure you.

**Do not** use water to clean the inside of the indoor unit. This can destroy insulation and cause electrical shock.

**Do not** expose filter to direct sunlight when drying. This can shrink the filter.

Any maintenance and cleaning of outdoor unit should be performed by an authorized dealer or a licensed service provider.

Any unit repairs should be performed by an authorized dealer or a licensed service provider.

**Maintenance - Long Periods of Non-Use**

If you plan not to use your air conditioner for an extended period of time, do the following:



Clean all filters



Turn on FAN function until unit dries out completely



Turn off the unit and disconnect the power

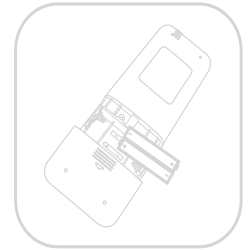

Remove batteries from remote control

**Fig. 18 — Long Periods of Non-Use**

**Maintenance - Pre-Season Use**

After long periods of non-use, or before periods of frequent use, do the following:



Check for damaged wires

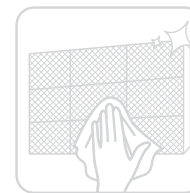

Clean all filters



Check for leaks



Make sure nothing is blocking all air inlets and outlets

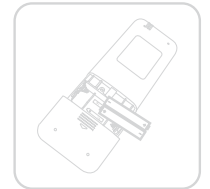

Replace batteries

**Fig. 19 — Pre-Season Use**

## TROUBLESHOOTING



### WARNING

#### SAFETY PRECAUTIONS

If any of the following conditions occur, turn off the unit immediately:

The power cord is damaged or abnormally warm.

You smell a burning odor.

The unit emits loud or abnormal sounds.

A power fuse blows or the circuit breaker frequently trips.

Water or other objects fall into or out of the unit.

**DO NOT** attempt to fix these issues yourself. Contact an authorized service provider immediately!

The issues in Table 1 are not malfunctions and in most cases do not require repairs.

**Table 1 — Common Issues**

Issue	Possible Causes
Unit does not turn on when user presses <b>ON/OFF</b>	The unit has a 3-minute protection feature that prevents the unit from overloading. The unit cannot be restarted within three minutes after being turned off.
The unit changes from <b>COOL/HEAT</b> mode to <b>FAN</b> mode	The unit may change its setting to prevent frost from forming on the unit. Once the temperature increases, the unit starts operating in the previously selected mode again.
	The set temperature has been reached, at which point the unit turns off the compressor. The unit continues operating when the temperature fluctuates again.
The indoor unit emits white mist	In humid regions, a large temperature difference between the room's air and the conditioned air can cause white mist.
Both the indoor and outdoor units emit white mist	When the unit restarts in the <b>HEAT</b> mode (after defrosting), white mist may be emitted due to moisture generated from the defrosting process.
	A rushing air sound may occur when the louver resets its position.
The indoor unit makes noises	A squeaking sound may occur after running the unit in the <b>HEAT</b> mode due to expansion and contraction of the unit's plastic parts.
	Low hissing sound during operation: This is normal and is caused by refrigerant gas flowing through both the indoor and outdoor units.
Both the indoor unit and outdoor unit make noises	Low hissing sound when the system starts, has just stopped running, or is defrosting. This noise is normal and is caused by the refrigerant gas stopping or changing direction.
	<b>Squeaking sound:</b> Normal expansion and contraction of plastic and metal parts caused by temperature changes during operation can cause squeaking noises.
The outdoor unit makes noises	The unit makes different sounds based on the current operating mode.
Dust emits from either the indoor or outdoor unit	The unit may accumulate dust after extended periods of non-use. Dust can emit when the unit is turned on. This can be mitigated by covering the unit during long periods of inactivity.
The unit emits a bad odor	The unit may absorb odors from the environment (such as furniture, cooking, cigarettes, etc.) which emits during operations.
	The unit's filters have become moldy and should be cleaned.
The outdoor unit fan does not operate	During operation, the fan speed is controlled to optimize product operation.
Operation is erratic, unpredictable, or unit is unresponsive	Interference from cell phone towers and remote boosters may cause the unit to malfunction. In this case, try the following:
	<ul style="list-style-type: none"> <li>• Disconnect the power, then reconnect.</li> <li>• Press <b>ON/OFF</b> on the remote control to restart operation.</li> </ul>

**NOTE: If an issue persists, contact a local dealer or your nearest customer service center. Provide them with a detailed description of the unit's malfunction as well as the unit's model number.**

## TROUBLESHOOTING (CONT)

When issues occur, please review the following common issues in Table 2 prior to contacting a service company.

**Table 2 — Troubleshooting Tips**

Problem	Possible Causes	Solution
Poor Cooling Performance	Temperature setting may be higher than the ambient room temperature	Lower the temperature setting
	The heat exchanger on the indoor or outdoor unit is dirty	Clean the affected heat exchanger
	The air filter is dirty	Remove the filter and clean it according to instructions
	The air inlet or outlet of either unit is blocked.	Turn the unit to remove the obstruction and turn it back on
	Doors and windows are open	Ensure all doors and windows are closed while operating the unit
	Excessive heat is generated by sunlight	Close windows and curtains during periods of high heat or bright sunshine
	There are too many heat sources in the room (people, computers, electronics, etc.)	Reduce the amount of heat sources
	Low refrigerant due to leak or long-term use	Check for leaks, re-seal if necessary and top off the refrigerant
	<b>SILENCE</b> function is activated (optional function)	<b>SILENCE</b> function can lower product performance by reducing operating frequency. Turn off <b>SILENCE</b> function.
The unit is not working	Power failure	Wait for the power to be restored
	The power is turned off	Turn on the power
	The fuse is burned out	Replace the fuse
	The unit's 3-minute protection has been activated	Wait three minutes after restarting the unit
	Timer is activated	Turn timer off
The unit starts and stops frequently	There is too much or too little refrigerant in the system	Check for leaks and recharge the system with refrigerant
	Incompressible gas or moisture has entered the system	Evacuate and recharge the system with refrigerant
	System circuit is blocked	Determine which circuit is blocked and replace the malfunctioning piece of equipment
	The compressor is broken	Replace the compressor
	The voltage is too high or too low	Install a manostat to regulate the voltage
Poor heating performance	The outdoor temperature is extremely low	Use an auxiliary heating device
	Cold air is entering through doors and windows	Ensure that all doors and windows are closed during use
	Low refrigerant due to leak or long-term use	Check for leaks, re-seal if necessary and top off refrigerant
Error code appears and begins with the letters as the following in the window display of the indoor unit: • E(x), P(x), F(x) • EH(xx), EL(xx), EC(xx) • PH(xx), PL(xx), PC(xx)	The unit may stop operation or continue to run safely. If the indicator lamps continue to flash or error codes appear, wait for about 10 minutes. The problem may resolve itself. If not, disconnect the power, then connect it again. Turn the unit on. If the problem persists, disconnect the power and contact your nearest customer service center.	

**NOTE: If your problem persists after performing the checks and diagnostics above, turn o your unit immediately and contact an authorized service center.**

## ERROR CODES

**Table 3 — Error Codes**

Display	Malfunction and Protection Indication
<b>EC07</b>	ODU Fan Speed Out of Control
<b>EC51</b>	ODU EEPROM Parameter Error
<b>EC52</b>	ODU Coil Temperature Sensor(T3) error
<b>EC53</b>	ODU Ambient Temperature Sensor (T4) Error
<b>EC54</b>	COMP. Discharge Temperature Sensor (TP) Error
<b>EC56</b>	IDU Coil Temperature Sensor (T2B) Error
<b>ECC1</b>	Other IDU Refrigerant Sensor Detects Leakage (Multi-zone)*
<b>EH00</b>	IDU EEPROM Malfunction
<b>EH03</b>	IDU Fan Speed Out of Control
<b>EH0A</b>	IDU EEPROM Parameter Error
<b>EH0E</b>	Water Level Alarm Malfunction
<b>EH12</b>	Main Unit or Secondary Units Malfunction
<b>EH3A</b>	External Fan DC bus voltage is too low protection
<b>EH3b</b>	External Fan DC bus voltage is too high fault
<b>EH60</b>	IDU Room Temperature (T1) Error
<b>EH61</b>	IDU Coil Temperature Sensor (T2) Error
<b>EH6a</b>	Communication Error between the indoor unit and the external fan module
<b>EHC1</b>	Refrigerant Sensor Detects Leakage
<b>EHC2</b>	Refrigerant Sensor is out of range and a leak is detected
<b>EHC3</b>	Refrigerant Sensor is out of range*
<b>EL01</b>	IDU and ODU Communication Error
<b>EL0C</b>	System lacks refrigerant
<b>EL11</b>	Communication Malfunction between the main and secondary units
<b>FH07</b>	IDU lift panel communication failure/IDU opening and closing failure
<b>FHCC</b>	Refrigerant Sensor Error*
<b>PC00</b>	ODU IPM Module Protection
<b>PC01</b>	ODU Voltage Protection
<b>PC02</b>	Compressor To (or IPM Module Protection)
<b>PC03</b>	Pressure Protection (Low or High Pressure)
<b>PC04</b>	Inverter Compressor Drive Error
<b>PC0L</b>	Low Ambient Temperature Protection
<b>NOTE:</b> The digital tube will display <b>FC</b> in the <b>FORCED COOLING</b> mode. <b>FC is NOT an error code.</b> *Applicable to the units with refrigerant sensors only.	

**Table 4 — Refrigerant Leak Detection Error Codes**

<b>EHC1</b>	Refrigerant Sensor detects a leak
<b>EHC2</b>	Working condition of the refrigerant sensor is out of range and a leak is detected

If you receive one of the codes in Table 8, call a technician as soon as possible. No need to panic, the unit goes into TURBO mode until the error code clears. There is a “beeping” noise coming from the indoor unit, which is normal in this case.

For additional diagnostic information, refer to the Service Manual.

